

© Vikarsh Nano Technology & Alloys Pvt Ltd 2022.

Copying, Publication or storing any content except as provided herewith is prohibited without prior written permission from Vikarsh Nano Technology & Alloys Pvt Ltd www.vikarshnano.com
sales1@vikarsh.com



NANOCRYSTALLINE MINIATURE CORES

PART#: 32.8-25-6.5

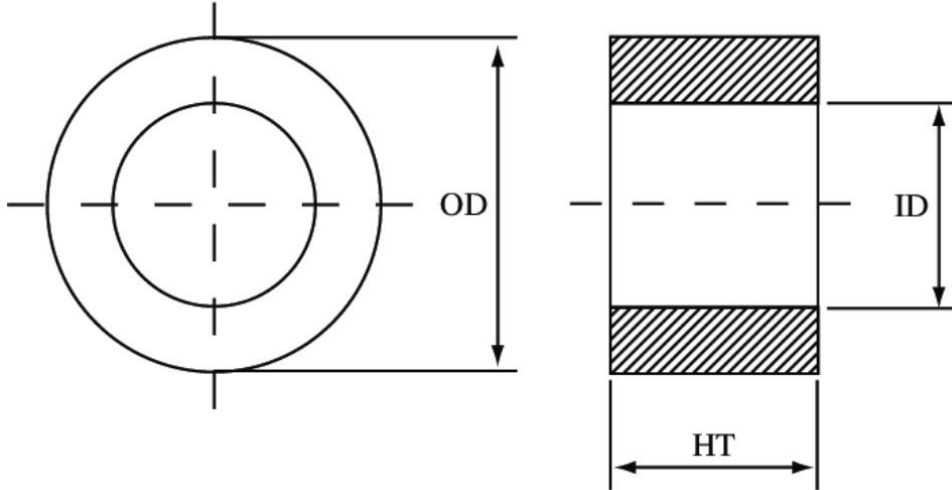

CORE AND CASE DIMENSIONS

CORE OD MM	CORE ID MM	CORE HT MM	CASE OD MM	CASE ID MM	CASE HT MM
32.80	25.00	6.50	34.30	23.00	8.20

CORE SPECIFICATIONS

- Outer Diameter D: 32.8mm (+0.5/-0)mm
- Inner Diameter d: 25mm (-0.5/+0)mm
- Height h: 6.5mm (+0.2/-0)mm
- Cross-Sectional Area A_e : 0.2cm²
- Mean Magnetic Path Length l_e : 9.07cm
- Stacking Factor: 80%
- Average Core Weight: 13.3grams
- Operating Temperature: -25°C~+110°C
- Max Temperature:- 130°C
- Input Current (mA):- 25mA
- Guaranteed Minimum Output Voltage (mV): 0.5mV
- Frequency: 50Hz
- $A_{ls}(\mu H)$ Typical: 25 μH (@1KHZ/1.0V)

